

NDISC PRO 15T 12V/24V DC



The nDisc series was designed using modern simulation methods in order to obtain the highest product quality.

- based on CREE® LEDs
- IP67
- made of 316L steel
- 12-24V DC
- 5-year warranty
- 15 W



Load	15 000 KG
Working temperature range	-20°C ÷ +55°C
IP protection class	IP67
Lifetime L80B10	≥ 60 000h
Impact resistance	IK10
Protection class	III
Connection	0.5m
Wiring	H07RN-F 2X1.5
Dimming	ON-OFF
Luminous flux tolerance	±10%
Angle of distribution	oval 40°x20°

TECHNICAL DRAWINGS

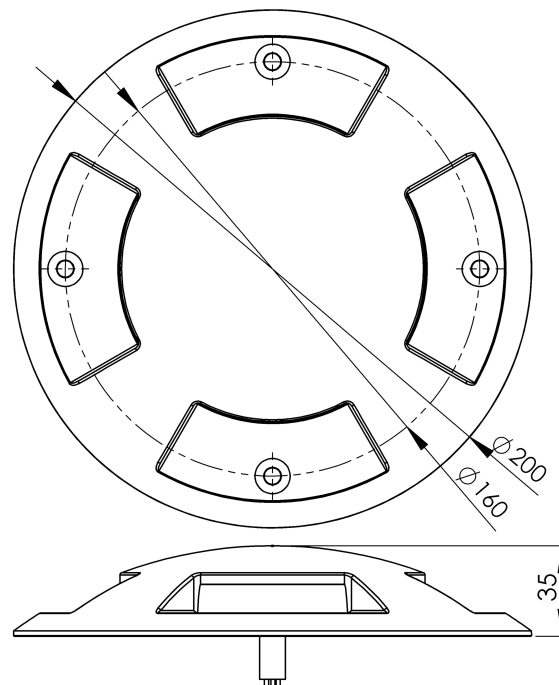

NDISC PRO 15T 12V/24V DC



The Niviss outdoor LED lighting fixture can be used for lighting many places and objects such as:

- parks
- gardens
- exterior walls
- squares
- premises
- plants

ELECTRICAL INSTALLATION

Connecting to the power supply should be done when the power supply is off.

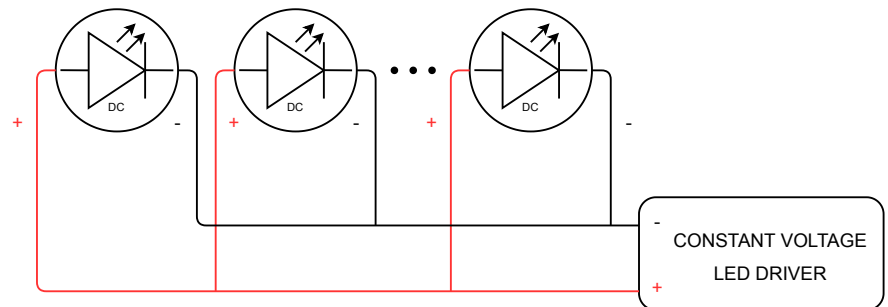

ORDER CODE AND TECHNICAL SPECIFICATIONS OF VARIANTS

VARIANT CODES IN THE TABLE BELOW TECHNICAL SPECIFICATIONS OF VARIANTS IN DATASHEET OF VARIANT















GENERAL TERMS OF USE

- Before using a luminaire, make sure what voltage range it is designed to.
- Connecting to the power supply should be done when the power supply is off.
- Use appropriate sockets and plugs: Ensure that your electrical sockets and plugs are compatible with the lamp's voltage and plug type.
- Use appropriate wiring for luminaires.
- Avoid overloading electrical circuits by not connecting too many lamps to a single outlet or circuit. Check the condition of the power cord and plug for any signs of damage or wear.
- Pay attention to the correct polarity when connecting the luminaires. Incorrect polarity may prevent the luminaires from functioning properly or could potentially damage them.
- Installation of the luminaires should be done by qualified person.
- Keep your luminaires clean and free from dust and debris, as it can affect their performance.
- Follow the luminaire connection diagram above.
- Avoid direct exposure of bright light sources to your eyes. Position luminaires in a way that minimizes direct glare or uncomfortable brightness.
- Ensure that the luminaire is placed on a stable surface and kept away from flammable materials. Allow sufficient clearance around the luminaire to prevent overheating.
- Keep away from fire.

ENVIRONMENTAL CAUTION!

It is prohibited to dispose of obsolete and waste electrical and electronic equipment together with regular household wastes. They should be properly sorted and recycled. Old electrical and electronic equipment should be returned to a waste collection point established by a waste-management service. Waste electrical and electronic equipment can be broken down to base materials and then recycled. For more information regarding waste management please contact your local authorities, waste-management service or the seller of electrical and electronic devices.

ORDER CODE AND TECHNICAL SPECIFICATIONS OF VARIANTS

Index	[DEG]	[K]	Lumen Output [lm]	CRI/RA	[W]	Power supply type	Body material	Front material	EAN	Front shape	Number of slots
NDISC-PRO-15T-15-NW-4-RD-SS-LV-R	40x20	4000	1500	≥80	15	12V/24V DC	SST	SST	5905658703806		
NDISC-PRO-15T-15-VW-4-RD-SS-LV-R	40x20	3000	1500	≥80	15	12V/24V DC	SST	SST	5905658703790		
NDISC-PRO-15T-15-NW-2-RD-SS-LV-R	40x20	4000	750	≥80	7.5	12V/24V DC	SST	SST	5905658703769		
NDISC-PRO-15T-15-VW-2-RD-SS-LV-R	40x20	3000	750	≥80	7.5	12V/24V DC	SST	SST	5905658703752		
NDISC-PRO-15T-15-VW-2-RD-AA-LV-R	40x20	3000	750	≥80	7.5	12V/24V DC	Alu	Alu	5905658703776		
NDISC-PRO-15T-15-NW-2-RD-AA-LV-R	40x20	4000	750	≥80	7.5	12V/24V DC	Alu	Alu	5905658703783		
NDISC-PRO-15T-15-VW-4-RD-AA-LV-R	40x20	3000	1500	≥80	15	12V/24V DC	Alu	Alu	5905658703813		
NDISC-PRO-15T-15-NW-4-RD-AA-LV-R	40x20	4000	1500	≥80	15	12V/24V DC	Alu	Alu	5905658703820	